



**Ferramenta inox**

[www.torbel.it](http://www.torbel.it)

## Spagnoletta tonda



- Semplice gestione del magazzino con soli 3 cod. prodotto.
- Facile da installare.
- Reversibile.
- Resistente alla corrosione.
- Elegante.

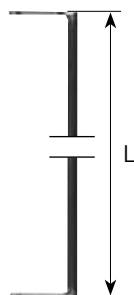

### Composizione

- 1 maniglia montata
- 1 incontro
- 4 guida asta rustici

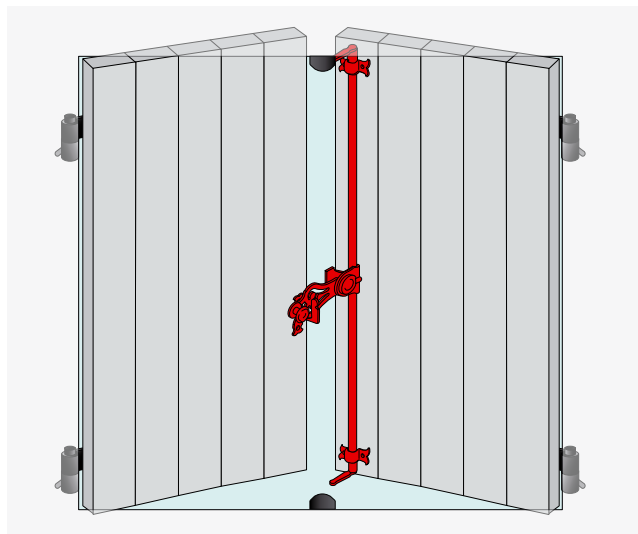

### Asta spagnoletta tonda

Cod.		L	
04IX150	316L	1500	5
04IX200	316L	2000	5
04IX250	316L	2500	5

### Insieme accessori spagnoletta tonda

Cod.		
07IX15Z	316L	5

### S903610

Dispositivo di battuta dritto a vite

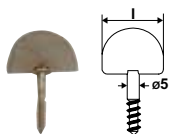

### S903650

Dispositivo di battuta regolabile

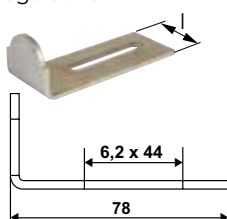

### S903620

Dispositivo di battuta con piega a vite

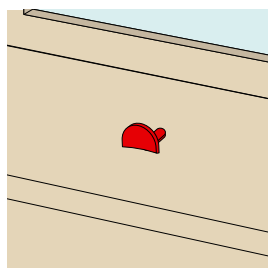
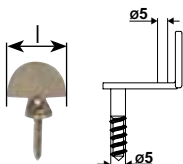

### Dispositivi di battuta

Cod.		l	
S903650Z	316L	30	1
S903610Z	316L	39	1
S903610	316L S	39	1
S903620Z	316L	36	1
S903620	316L S	36	1
S903650	316L S	30	50



Nella parte alta preferire la battuta regolabile per evitare lo sgretolio dell'intonaco.

## Spagnoletta piatta



Per anta destra o sinistra grazie ai supporti e guida asta reversibili.  
Ideale per spazi ridotti tra finestra e persiana.  
Incontro ergonomico su anta di riporto.  
Movimentazione fluida della maniglia.  
Elegante ed innovativa.

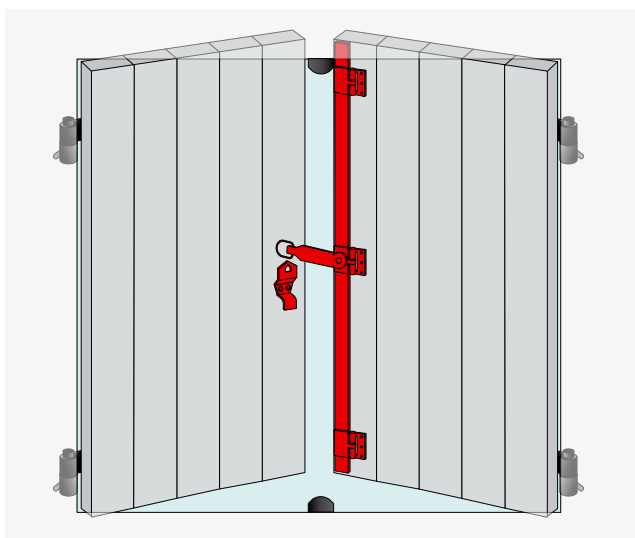

### Asta spagnoletta piatta

Cod.		L	
<b>Maniglia a 0,50 m dal basso</b>			
S907015Z	316L	1500	1
S907020Z	316L	2000	1
S907015PB	316L S	1500	1
S907020PB	316L S	2000	1
<b>Maniglia a 1,35 m dal basso</b>			
S907021Z	316L	2000	1
S907025Z	316L	2500	1
S907030Z	316L	3000	1
S907021PB	316L S	2000	1
S907025PB	316L S	2500	1
S907030PB	316L S	3000	1

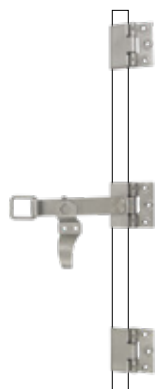

### Composizione

- 1 maniglia piatta
- 1 supporto maniglia
- 2, 3 o 4 guida asta
- 1 incontro

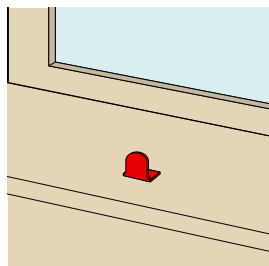
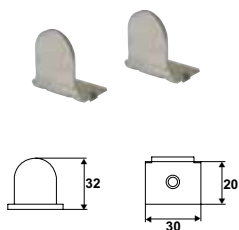

### Insieme accessori spagnoletta piatta

Cod.		
<b>2 guida asta</b>		
S907620Z	316L	20
S907620PB	316L S	20
<b>3 guida asta</b>		
S907630Z	316L	20
S907630PB	316L S	20
<b>4 guida asta</b>		
S907640Z	316L	20
S907640PB	316L S	20

### Insieme 2 fermi

Cod.		
071X01Z	304L	1

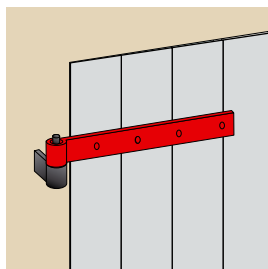
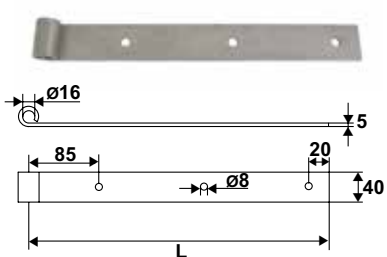
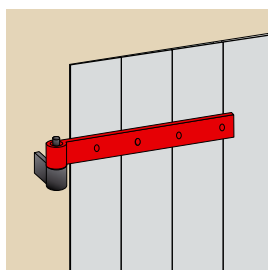
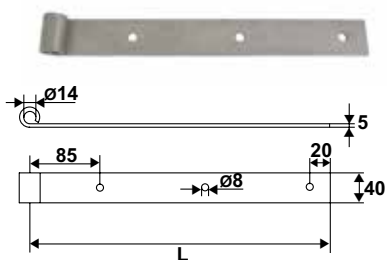
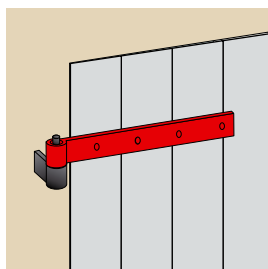
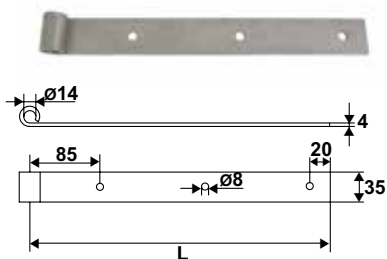

**Bandella dritta 35x4 Ø14**

Cod.		L	
S900143Z	316L	300	1
S900144Z	316L	400	1
S900145Z	316L	500	1
S900146Z	316L	600	1
S900147Z	316L	700	1
S900148Z	316L	800	1
S900143	316L S	300	1
S900144	316L S	400	1
S900145	316L S	500	1
S900146	316L S	600	1
S900147	316L S	700	1
S900148	316L S	800	1

**Bandella dritta 40x5 Ø14**



Cod.		L	
S9003803	316L	600	1

**Bandella dritta 40x5 Ø16**

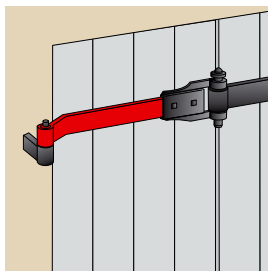
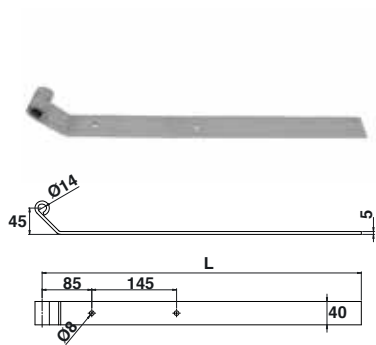
Cod.		L	
S900343Z	316L	300	1
S900344Z	316L	400	1
S900355Z	316L	500	1
S900346Z	316L	600	1
S900347Z	316L	700	1
S900340Z	316L	800	1
S900341Z	316L	1000	1
S900342Z	316L	1200	1
S900345Z	316L	1500	1
S900343	316L S	300	1
S900344	316L S	400	1
S900355	316L S	500	1
S900346	316L S	600	1
S900347	316L S	700	1
S900340	316L S	800	1
S900341	316L S	1000	1
S900342	316L S	1200	1
S900345	316L S	1500	1



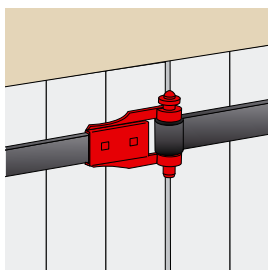
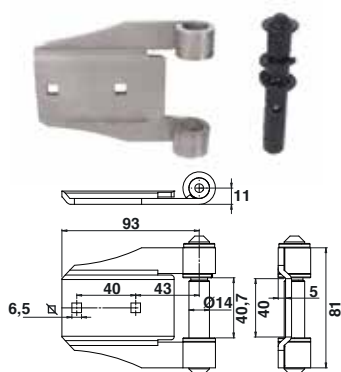

**Bandella dritta con piega  
40x5 Ø14**

Cod.		L	
S900770Z	316L	600	1
S900770	316L S	600	1



**Articolazione Ø14 + perno  
per bandella dritta**

Cod.		L	
S904500Z	316L	10	
S904500	316L S	10	

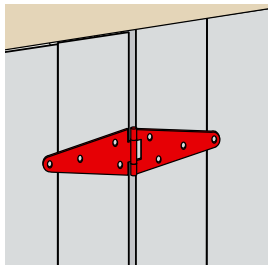
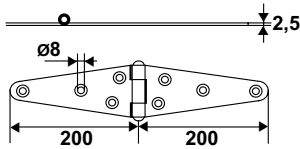
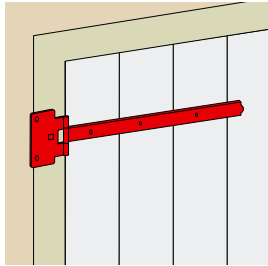
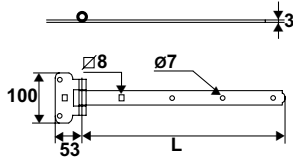
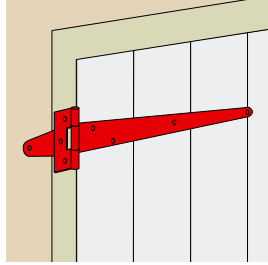
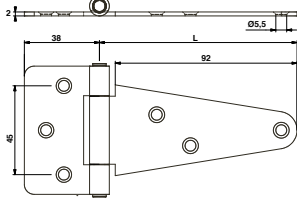

## Cerniere





### Cerniera inglese

Cod.		L	
S904110Z	316L	100	1
S904115Z	316L	150	1
S904120Z	316L	200	1
S904125Z	316L	250	1
S904130Z	316L	300	1
S904110	316L S	100	1
S904115	316L S	150	1
S904120	316L S	200	1
S904125	316L S	250	1
S904130	316L S	300	1

### Cerniera decorativa

Cod.		L	
S904330Z	316L	300	1
S904340Z	316L	400	1
S904350Z	316L	500	1
S904360Z	316L	600	1
S904330	316L S	300	1
S904340	316L S	400	1
S904350	316L S	500	1
S904360	316L S	600	1

### Cerniera a cuneo

Cod.		
S904020Z	316L	1
S904020	316L S	1

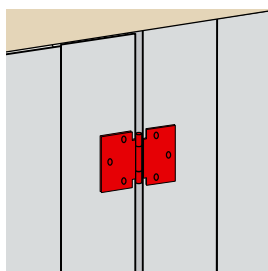
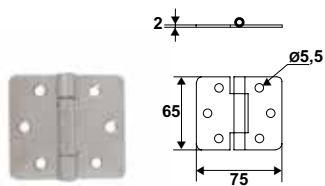

**Cerniera semplice**

Cod.		
S904100Z	316L	1
S904100	316L S	1

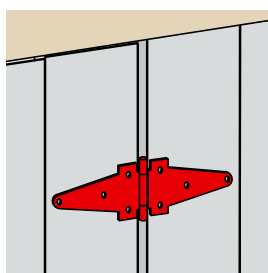
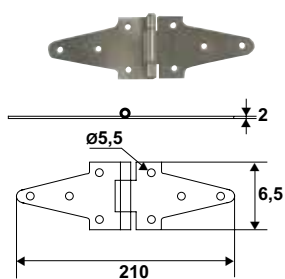

**Cerniera rinforzata**

Cod.		
S904200Z	316L	1
S904200	316L S	1

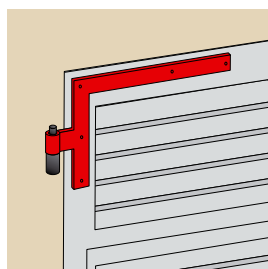
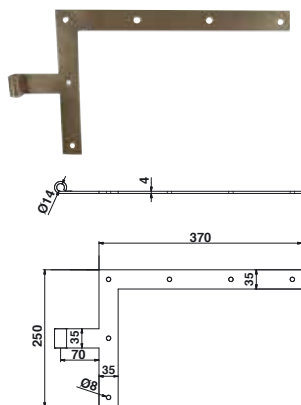

**Squadro punta quadra 35x4 Ø14**

Cod.		
<b>Destro</b>		
S900528Z	316L	1
S900528	316L S	1
<b>Sinistro</b>		
S900514Z	316L	1
S900514	316L S	1

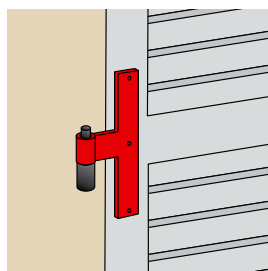
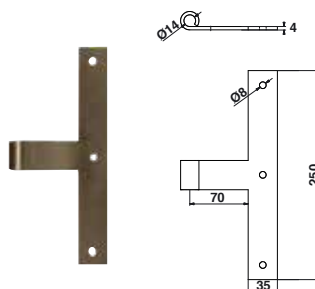

**T di mezzo 35x4 Ø14**

Cod.		
S900614Z	316L	1
S900614	316L S	1

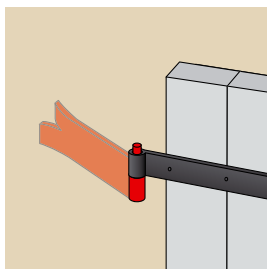
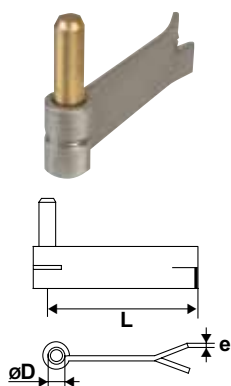

Cardine a murare 1 lama con perno ottone

Cod.		ØD	L	e	
S901146Z	316L	16	180	5	1
S901144	316L S	14	135	4	1
S901146	316L S	16	180	5	1

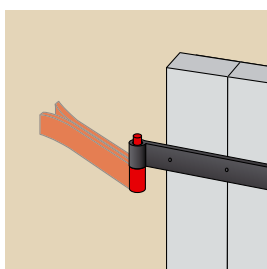
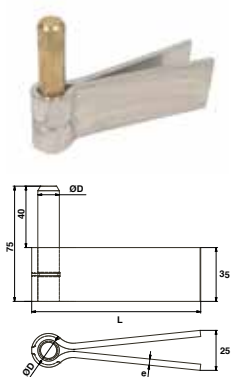

Cardine a murare 2 lame con perno ottone

Cod.		ØD	L	e	
S901244Z	316L	16	110	4	10
S901246Z	316L	16	120	5	1
S901244	316L S	14	110	4	1
S901246	316L S	14	120	5	1

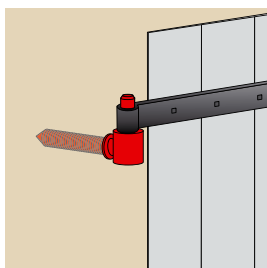
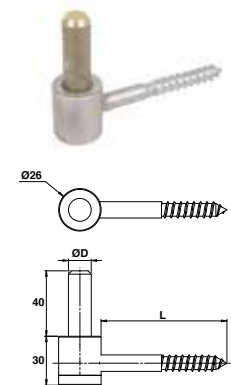

Cardine vite legno

Cod.		ØD	
S900414Z	316L	Ø14	1
S900414	INOX B	Ø14	1
S900416	INOX B	Ø16	1

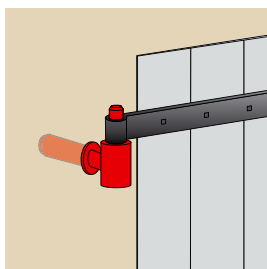
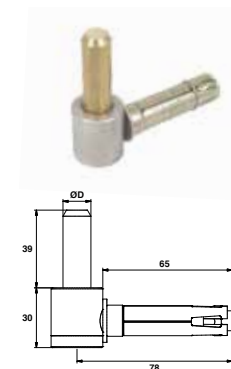

Cardine con tassello meccanico



Cod.		ØD	
S901416Z	316L	Ø16	1
S901414	316L S	Ø14	1

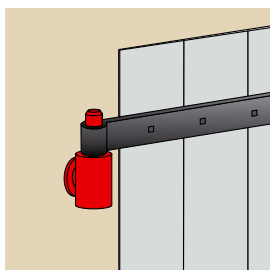
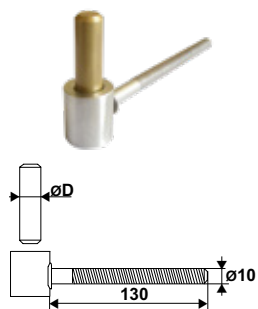

## Cardini



### Cardine per resina chimica

Cod.		ØD	
61IX14Z	316L	Ø14	10
61IX16Z	316L	Ø16	10
61IX14PB	316L S	Ø14	10
61IX16PB	316L S	Ø16	10

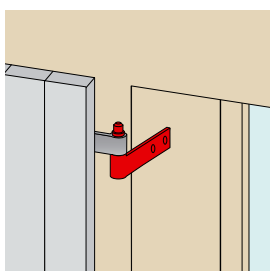
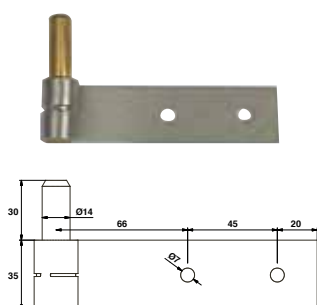

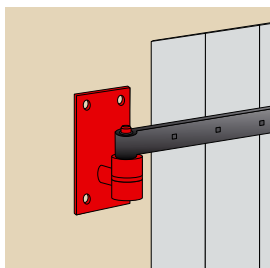
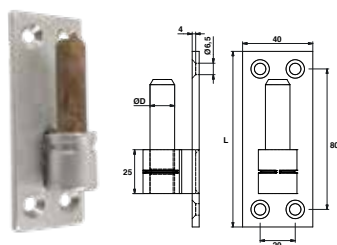

### Cardine a piastra 35x4 Ø14

Cod.		
S901088Z	316L	10



### Cardine su piastra

Cod.		L	ØD	
S901314Z	316L	100	Ø14	1
S901316Z	316L	100	Ø16	10
S901314	316L S	100	Ø14	1
S901316	316L S	180	Ø16	1

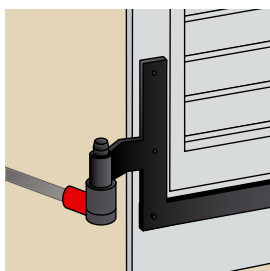
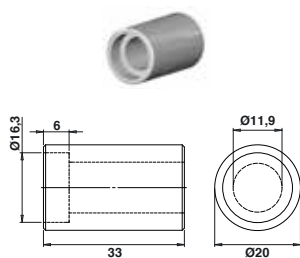

### Distanziale

Cod.		
S900450	316L	150

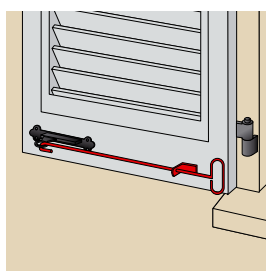
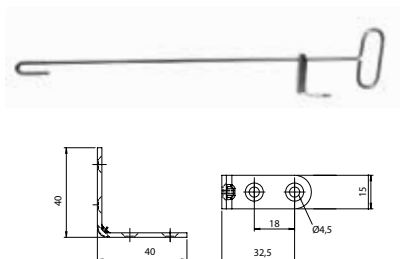
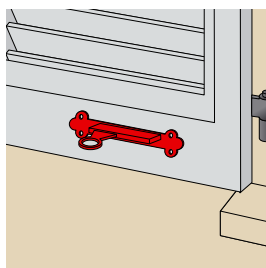
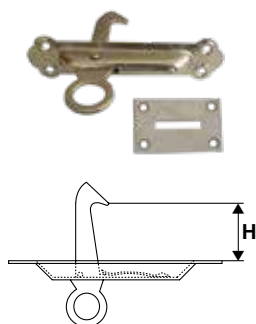
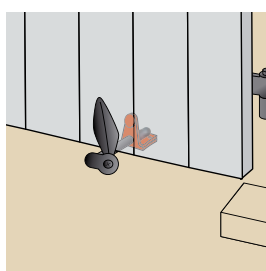
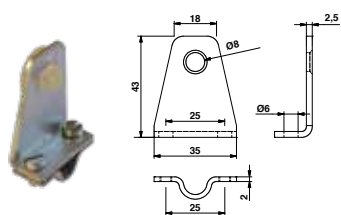
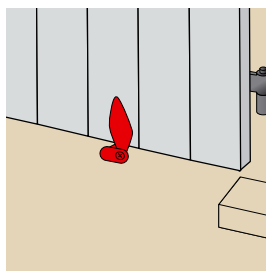

Frulletto vite legno

Cod.		L	
S901513Z	316L	130	10
S901518Z	316L	180	10
S901513	316L S	130	1
S901518	316L S	180	10

Battuta per frulletto marsigliese Ø10

Cod.		
S901525	316L	1

Fermo a molla passante

Cod.		H	
92IX120	304L	45	10
92IX130	304L	55	10
92IX130J	9005	55	10
92IX130P	9016	55	10

Braccetto per fermo a molla passante inox

Cod.		L	Squadra	
92IX200	304L B	400	40x40	10
92IX200E	9005	400	40x40	10

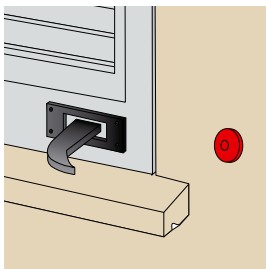
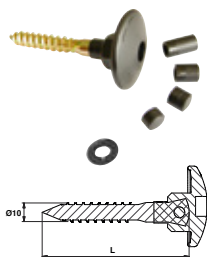

**Aggancio regolabile fermo a molla**

Cod.		L	
92CR106		75	50
92CR116		180	50

**Composizione**

- 1 battuta aggancio + 1 rondella
- 4 distanziali di regolazione

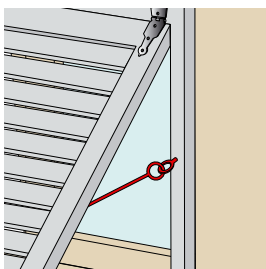
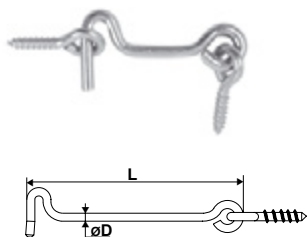

**Gancio da avvitare**

Cod.		ØD	L	
S902650	<b>316L S</b>	Ø3,5	50	1
S902660	<b>316L S</b>	Ø4	60	1
S902610	<b>316L S</b>	Ø4,5	100	1
S902616	<b>316L S</b>	Ø5	160	1

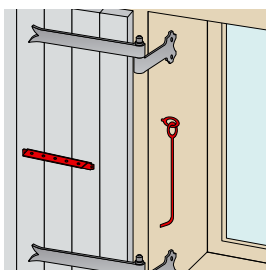
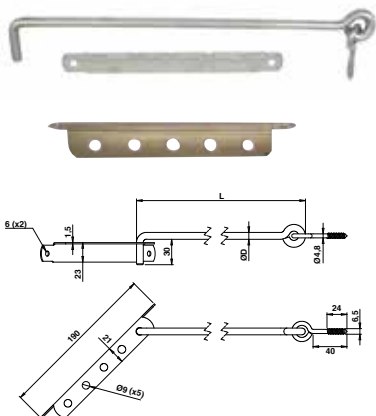

**Gancio con cremagliera**

Cod.		ØD	L	
S902525	<b>316L</b>	Ø8	250	10
S902530	<b>316L</b>	Ø8	300	10
S902540	<b>316L</b>	Ø8	400	10

**Cremagliera Ø 8,5**

S902500	<b>316L</b>	Ø8,5	190	10
---------	-------------	------	-----	----

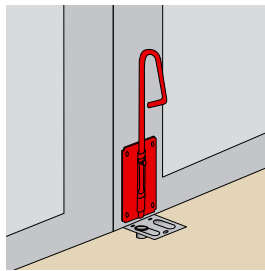
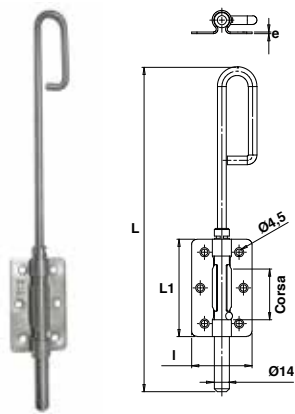

Chiavistello a baionetta Ø14

Cod.		L	L1 x l x e	
S902025	<b>316L S</b>	250	90x56x1,5	1
S902030	<b>316L S</b>	300	90x56x1,5	1
S902035	<b>316L S</b>	350	90x56x1,5	1
S902040	<b>316L S</b>	400	90x56x1,5	1

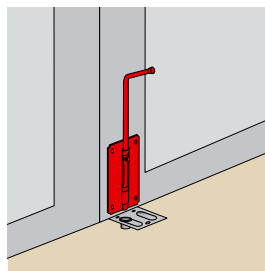
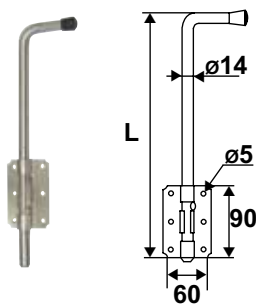

Chiavistello a maniglia 90°

Cod.		L	
S902414	<b>316L S</b>	300	1

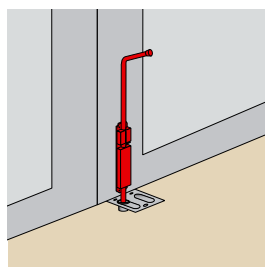
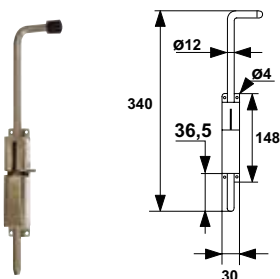

Chiavistello inox a molla

Cod.		e	
I640700012	<b>316L S</b>	1,5	1

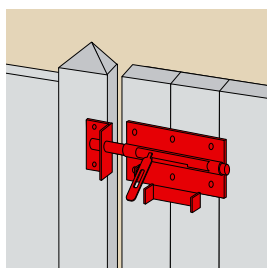
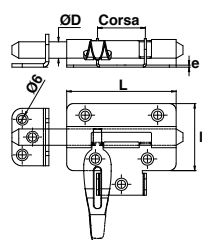

## Chiavistello porta lucchetto rinforzato

Cod.		ØD	L x l x e	
S902110	<b>316L S</b>	10	65x62x1,5	1
S902112	<b>316L S</b>	12	80x49x1,5	1
S902114	<b>316L S</b>	14	90x56x2	1

Prodotto rinforzato grazie allo spessore della sua piastra. Ottima estetica e finitura. Chiavistello piatto porta lucchetto per lucchetto Ø8.

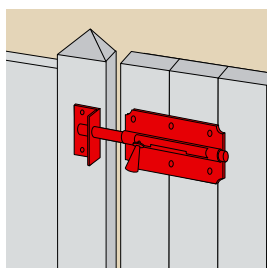
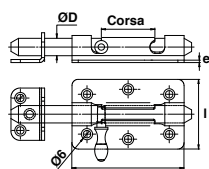

## Chiavistello rinforzato

Cod.		ØD	L x l x e	
S902210	<b>316L S</b>	10	65x48x1,5	1
S902212	<b>316L S</b>	12	80x49x1,5	1
S902214	<b>316L S</b>	14	90x56x1,5	1

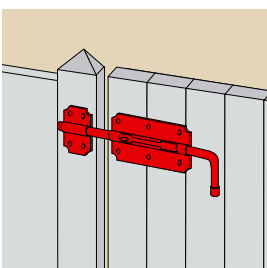
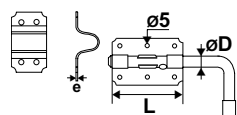

## Chiavistello a pistola con aggancio

Cod.		L	ØD	e	
S902310	<b>316L S</b>	65	10	1	1
S902312	<b>316L S</b>	80	12	1	1
S902314	<b>316L S</b>	90	14	1	10

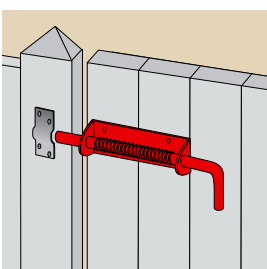
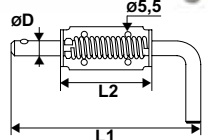

## Chiavistello da stalla a molla (senza aggancio)

Cod.		L1	L2	ØD	
S902515	<b>316L S</b>	180	86	14	1

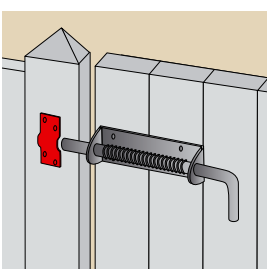
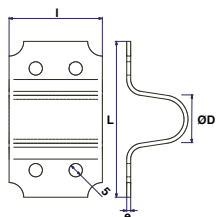
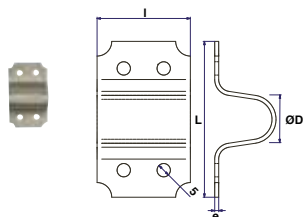

## Aggancio per chiavistello

Cod.		L	l	ØD	e	
S900010	<b>316L S</b>	49	20	10	1,5	1
S900012	<b>316L S</b>	55	22	12	1,5	1
S900014	<b>316L S</b>	61	35	14	1,5	1

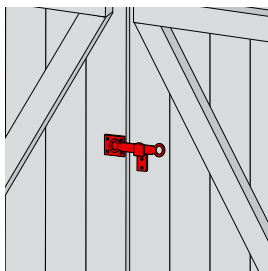
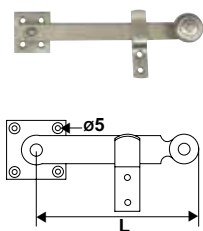

Chiusura per persiana

Cod.		L	
S903516	316L S	150	1
S903520	316L S	200	1

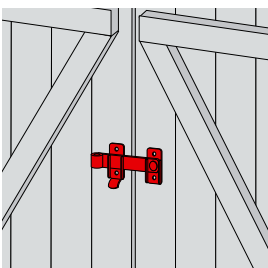
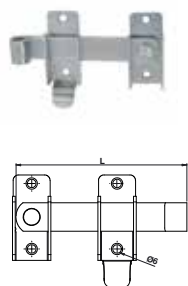

Chiusura centrale e aggancio a tirare

Cod.		L	
S918120	316L	120	10

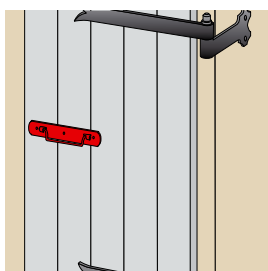
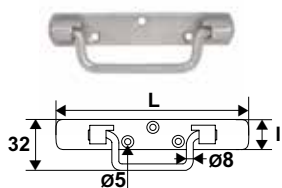

Maniglia per persiana su piastra

Cod.		L	I	
S900114	316L S	140	25	1

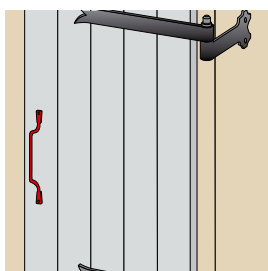
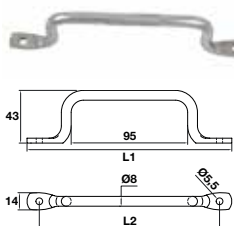

Maniglia per persiana

Cod.		L1	L2	
S900118	316L PS	167	147	5

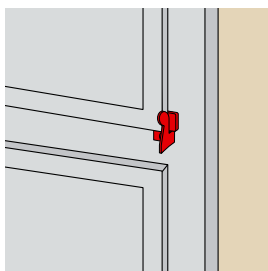
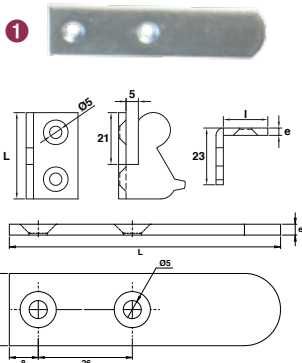

Aggancio per scuro interno

Cod.		L	I	e	
<b>1</b> Piatto					
90IX10Z	304L	75	20	3	1
<b>2</b> Piegato Destra					
90IX01Z	304L	35	18	3	1
<b>3</b> Piegato Sinistra					
90IX02Z	304L	35	18	3	1