

Cremonesi decorative

www.torbel.it

RY 16 per asta mezza tonda 16x5 mm

Composizione

- 1 Corpo maniglia RY16
- 1 Passante
- 2 terminali / incontri a sormonto di 10 mm
- 1 Quadro 7x40 mm
- 1 kit viti (eccetto per il modello grezzo)



Per aste mezze tonde 16x5 P.249

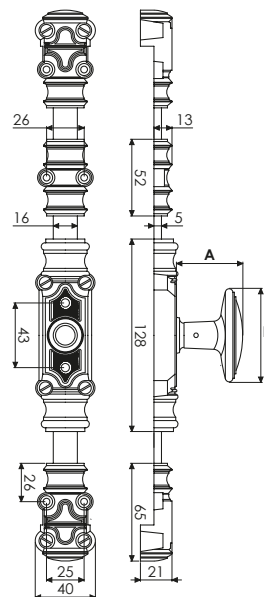

RY 16 Modello standard

Cod.		A	B	
J041346	GREZZO	44	66	10
J041344	EPOXY	44	66	10

Cremonesi decorative rustiche rinforzate ghisa

RY 59 per asta mezza tonda 16x8 mm

Composizione



- 1 Corpo maniglia RY59
- 1 Quadro 7x40 mm
- 1 Passante
- 1 kit viti (eccetto per il modello grezzo)
- 2 terminali / incontri a sormonto di 10 mm

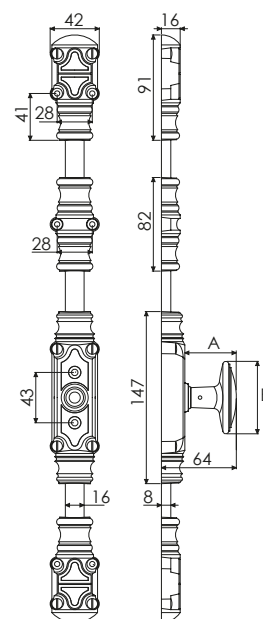

Per aste mezze tonde 16x8 P.249



RY 59 Modello Confort

Cod.		A	B	
J041126	GREZZO	50	72	1
J041127	EPOXY	50	72	1
J041129	GRIGIO	50	72	1

Una maniglia più grande per facilitare l'impugnatura.



RY 59 Modello in ottone lucidato



Cod.		A	B	
J041147	EPOXY	42	62	1

Pomoli rustici

Pomoli rustici su rosetta in zama



Pomolo Comfort senza quadro

Cod.		Sp.	
J073680	EPOXY	6	10
J073679	GREZZO	6	10

Prevedere quadro 7 mm.
Incastro del quadro 25 mm.



Quadro 7 mm

Cod.		Sp.	
J571894	GREZZO	65	100

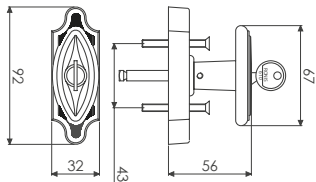

Pomolo con serratura + quadro 7 mm

Cod.		
J073682	EPOXY	10

Serratura Ronis n°610 fornita di 2 chiavi n°611.



Pomolo Comfort con quadro

Cod.		
J073695	EPOXY	10

Consegnato con quadro 7 mm L65 mm.
Incastro del quadro 25 mm.

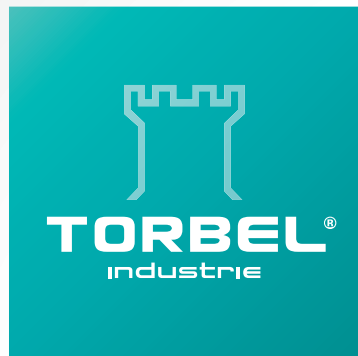

Cremonesi

www.torbel.it

Cremonesi rustiche in ghisa

RY16 per asta mezza tonda 16x5 mm

Composizione

- 1 Corpo maniglia RY16
- 1 Passante
- 2 Terminali
- 2 Incontri
- 1 kit viti(ad eccezione del modello grezzo e primer)



- Guide anti sfregamento



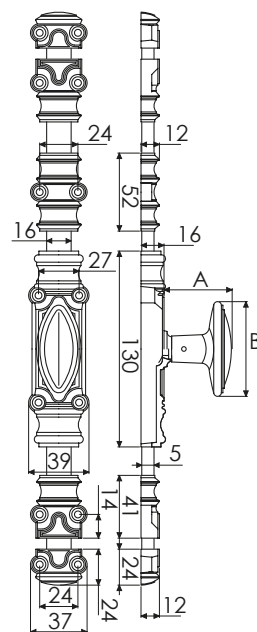

Per aste mezze tonde 16x5 P.249



RY 16 Modello standard



Cod.		A	B	
J380003	GREZZO	44	66	1
J041362	PRIMER	44	66	1
J041376	EPOXY	44	66	1
J041381	GRIGIO	44	66	1

RY 16 Modello in ottone cesellato

Cod.		A	B	
J041363	EPOXY	38	66	1



RY 16 Modello in ottone lucidato

Cod.		A	B	
J041373	EPOXY	42	62	1

Cremonesi rustiche rinforzate in ghisa

RY59 per asta mezza tonda 16x8 mm

Composizione

- 1 Corpo maniglia RY59
- 1 Passante
- 2 Terminali
- 2 Incontri
- 1 kit viti (ad eccezione del modello grezzo e primer)

• Guide anti sfregamento



Per aste mezze tonde 16x8 P.249

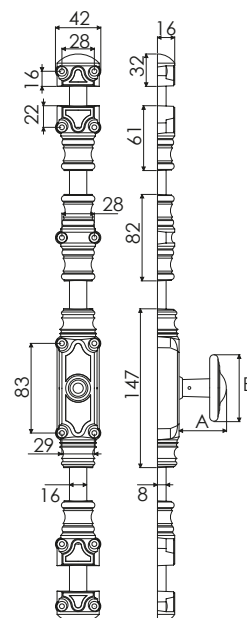

RY 59 Modello Confort

Cod.		A	B	
J380005	GREZZO	50	72	1
J041183	PRIMER	50	72	1
J041185	EPOXY	50	72	1
J041181	GRIGIO	50	72	1

Una maniglia più grande per facilitare l'impugnatura.



RY 59 Modello in ottone cesellato

Cod.		A	B	
J041261	EPOXY	38	66	1



RY 59 Modello in ottone lucidato

Cod.		A	B	
J041278	EPOXY	42	62	1

Cremonesi rustiche rinforzate in ghisa

Rinforzata RY59 per asta mezza e mezza tonda 16x8 mm

Composizione

- 1 Corpo maniglia RY59
- 1 Passante
- 2 Terminali
- 2 Incontri
- 1 kit viti (ad eccezione del modello grezzo e primer)



Per aste mezza
tonde 16x8
P.249

- Guide anti sfregamento

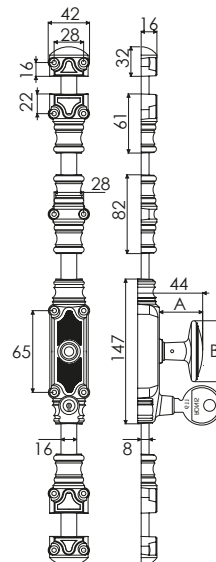

RY 59 Modello con serratura (RY60)

Cod.		A	B	
J041300	GREZZO	44	65	1
J041291	PRIMER	44	65	1
J041293	EPOXY	44	65	1
J041294	GRIGIO	44	65	1



Cremonese RY59 senza pomolo

Cod.		
J041268	EPOXY	1

Cremonesi rustiche rinforzate in ghisa

Rinforzata RY 70 per asta mezza tonda 18x9 mm

Composizione

- 1 Corpo maniglia RY70
- 1 Passante
- 2 Terminali
- 2 Incontri
- 1 kit viti



Per aste mezze
tonde 18x9
P.249



RY 70 Modello rustico rinforzato

Cod.		A	B	
J042101	GREZZO	50	72	1
J042100	PRIMER	50	72	1
J042102	EPOXY	50	72	1

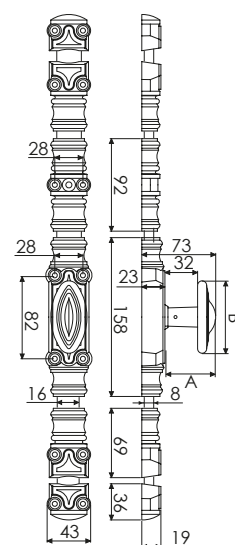

Una maniglia più grande per facilitare l'impugnatura.

Classica RY50/51/52 e RA per asta mezza tonda 16x5 / 16x8 mm

Composizione

- 1 Corpo maniglia RY50/51/52 o RA
- 1 Passante
- 2 Terminali
- 2 Incontri
- 5 elementi di guarnitura

NB: Gli elementi di guarnitura servono come passanti, terminali e/o incontri.

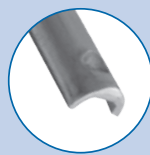

RY50 / 51 / 52
Per aste mezze tonde 16x8
P.249



RA
Per aste mezze tonde 16x5
P.249

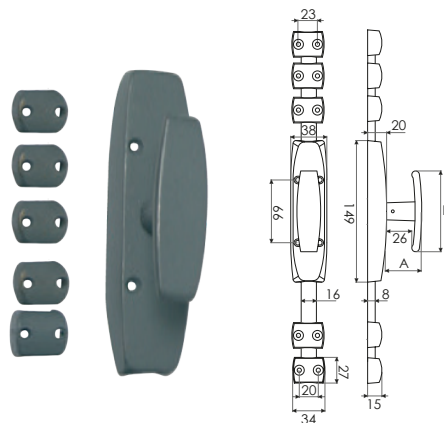

RY 50/51 Modello standard in ghisa

Cod.		A	B	
J041118	PRIMER	37	85	1
J041110	EPOXY	37	85	1

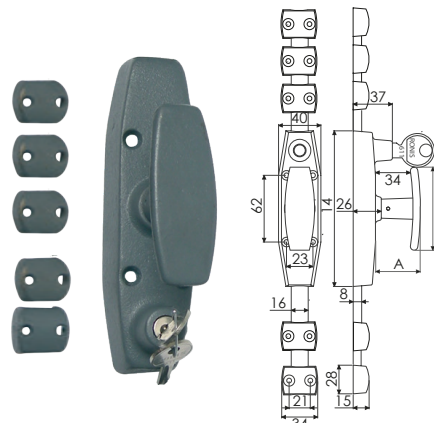

RY 50/51 Modello con serratura

Cod.		A	B	
J041761	PRIMER	37	79	1

Serratura RONIS. Fornita con 2 chiavi N° 611.

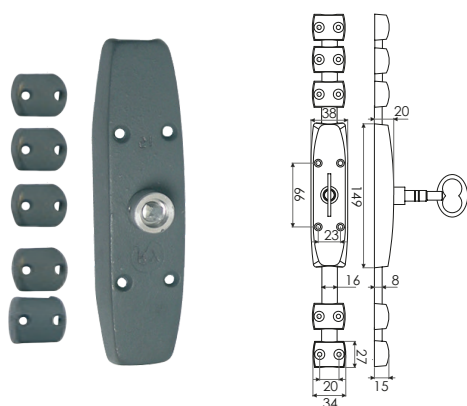

RY 50/51 Modello con inserto quadro integrato

Cod.		A	B	
J041115	PRIMER	11,5	18	1

Chiave non fornita. Quadro 7 mm.
Tondo Ø12,5 mm.

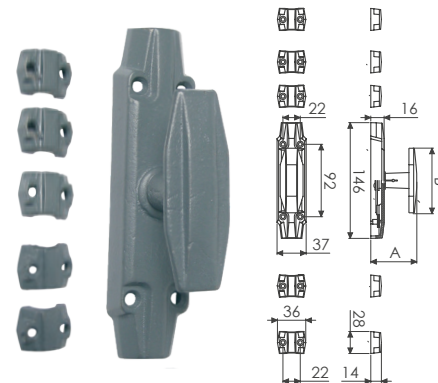

RA Modello standard

Cod.		A	B	
J380002	GREZZO	21	41	1
J041320	PRIMER	21	41	1

Cremonesi per porte carraie in ghisa

Composizione

- 1 Corpo maniglia porta carraia
- 2 Terminali (1 alto + 1 basso)
- 1 Passante
- 1 Incontro alto

NB : Cremonese montata su asta tonda con un incontro nella parte alta; nessun incontro nella parte bassa perché l'asta entra nella soglia in posizione chiusa.

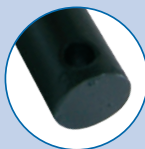

Per aste tonde Ø 18
P.249

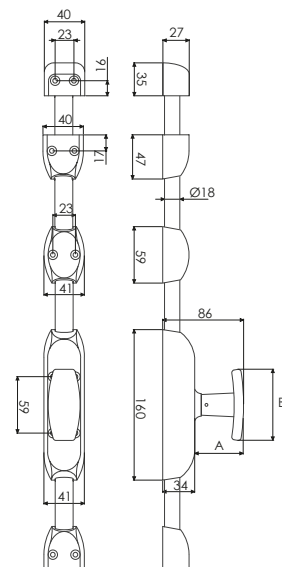

RY 180 Modello classico

Cod.		A	B	
J041605	PRIMER	52	75,5	1



RY 180 Modello classico con serratura

Cod.		A	B	
J041607	PRIMER	52	75,5	1

Serratura Ronis n°610 fornita di 2 chiavi n°611.

Asta mezza tonda e tonda acciaio



Asta mezza tonda acciaio 16x5 mm

Cod.	Modello	L	
J062103	GREZZO	16x5	1300 20
J062120	GREZZO	16x5	2440 20
J062173	EPOXY	16x5	1300 20
J062170	EPOXY	16x5	1540 20
J062180	EPOXY	16x5	1940 20
J062190	EPOXY	16x5	2440 20
J062213	Z.BIANCO	16x5	1300 20
J062215	Z.BIANCO	16x5	1940 20
J062220	Z.BIANCO	16x5	2440 20
J062021	GRIGIO	16x5	1300 20
J062026	GRIGIO	16x5	2440 20

Per cremonesi decorative RY16D P.238
Per cremonesi RY16 P.242 Per cremonesi CSI P.247



Asta mezza tonda acciaio 16x8 mm

Cod.	Modello	L	
J062413	GREZZO	16x8	1300 15
J062420	GREZZO	16x8	2440 10
J062553	EPOXY	16x8	1300 15
J062570	EPOXY	16x8	2440 10
J062513	Z.BIANCO	16x8	1300 15
J062520	Z.BIANCO	16x8	2440 10
J062733	GRIGIO	16x8	1300 15
J062542	GRIGIO	16x8	2440 10

Per cremonesi RY59 P.239, P.243, P.244, P.245,
Per cremonesi RY50/51/52 P.246



Asta mezza tonda acciaio 18x9

Cod.	Modello	L	
J062710	GREZZO	18x9	1940 10
J062720	GREZZO	18x9	2440 10
J062763	EPOXY	18x9	1300 10
J062765	EPOXY	18x9	2440 10
J062753	Z.BIANCO	18x9	1300 10
J062750	Z.BIANCO	18x9	1940 10
J062760	Z.BIANCO	18x9	2440 10
J062754	GRIGIO	18x9	1300 10
J062764	GRIGIO	18x9	2440 10

Per cremonesi RY70 P.244



Asta tonda Ø18 mm

Cod.	Modello	L	
J062800	GREZZO	Ø18	1500 1
J062810	EPOXY	Ø18	1500 1
J062830	EPOXY	Ø18	3000 1

Per cremonesi porte carraie RY180 P.248

Asta tonda Ø22 mm

Cod.	Modello	L	
J062850	GREZZO	Ø22	1500 1
J062860	EPOXY	Ø22	1500 1
J062880	EPOXY	Ø22	3000 1

Per cremonesi porte carraie RY220 P.248

Incontro

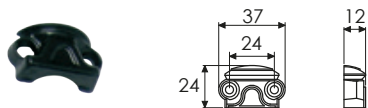

Incontro RY 16

Cod.	Icona	Sp.
J053586	GREZZO	1
J053585	PRIMER	1
J053595	EPOXY	1

Per aste mezza tonde 16x5 P.249

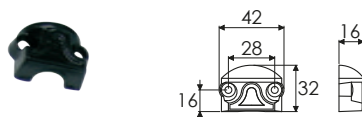

Incontro RY 59

Cod.	Icona	Sp.
J053580	GREZZO	1
J053589	PRIMER	1
J053590	EPOXY	1

Per aste mezza tonde 16x8 P.249

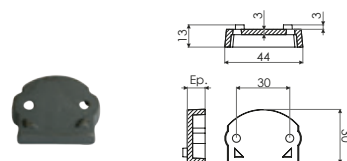

Spessore per incontro per RY59

Cod.	Icona	Sp.
J053596	GREZZO	6 1
J053597	GREZZO	10 100
J053598	GREZZO	14 50
J053572	GREZZO	19 1
J053581	EPOXY	6 1
J053582	EPOXY	10 1
J053583	EPOXY	14 10
J053584	EPOXY	19 1
J053591	PRIMER	6 1
J053592	PRIMER	10 100
J053594	PRIMER	14 1
J053593	PRIMER	19 1



Incontro RY 70

Cod.	Icona	Sp.
J053500	GREZZO	1
J053501	PRIMER	1

Per aste mezza tonde 18x9 P.249

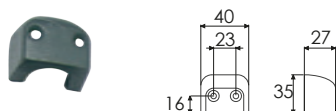

Incontro RY 180

Cod.	Icona	Sp.
J053318	PRIMER	1

Per aste tonde Ø 18 mm P.249

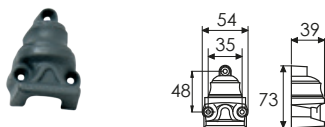

Incontro RY 220

Cod.	Icona	Sp.
J053191	PRIMER	1

Per aste tonde Ø 22 mm P.249



Incontro per RA Standard

Cod.	Icona	Sp.
J052653	PRIMER	1

Per aste mezza tonde 16x5 P.249

Terminali



Terminale RY 16



Cod.  

J055585 **PRIMER** 1

J055595 **EPOXY** 1

Per aste mezze tonde 16x5 P.249

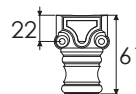

Terminale RY 59



Cod.  

J055589 **GREZZO** 1

J055580 **PRIMER** 1

J055590 **EPOXY** 1

Per aste mezze tonde 16x8 P.249

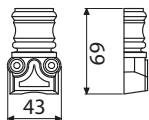

Terminale RY 70



Cod.  

J055586 **GREZZO** 1

J055501 **PRIMER** 1

Per aste mezze tonde 18x9 P.249

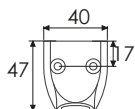

Terminale RY 180



Cod.  

J055318 **PRIMER** 1

Per aste tonde Ø18 mm P.249

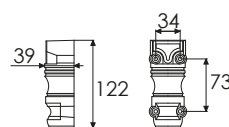

Terminale RY 220



Cod.  

J055191 **PRIMER** 1

Per aste tonde Ø 22 mm P.249

Passante

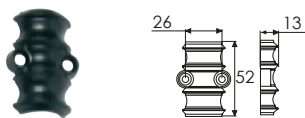

Passante RY 16

Cod.	Icona	Icona
J054587	GREZZO	1
J054585	PRIMER	1
J054595	EPOXY	1

Per aste mezzе tonde 16x5 P.249

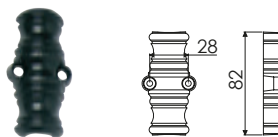

Passante RY 59

Cod.	Icona	Icona
J054589	GREZZO	1
J054580	PRIMER	1
J054590	EPOXY	1

Per aste mezzе tonde 16x8 P.249

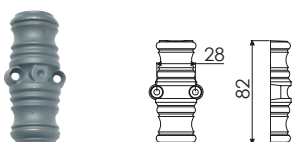

Passante RY 70

Cod.	Icona	Icona
J054503	GREZZO	1
J054501	PRIMER	1
J054502	EPOXY	1

Per aste mezzе tonde 18x9 P.249

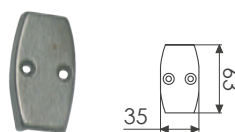

Passante 164

Cod.	Icona	Icona
J053630	GREZZO	1

Per aste piatte 16x4 mm P.249

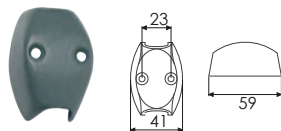

Passante RY 180

Cod.	Icona	Icona
J054318	PRIMER	1

Per aste tonde Ø18 mm P.249

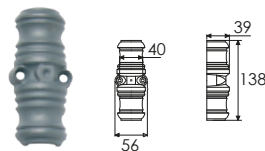

Passante RY 220

Cod.	Icona	Icona
J054191	PRIMER	1

Per aste tonde Ø22 mm P.249

Accessori

Incontri

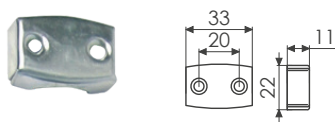

Incontro classica piatta

Cod.



J057040 **Z.BIANCO** 1

Per aste mezze tonde 16x5 P.249

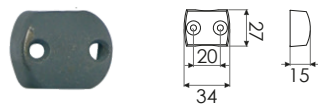

Incontro RY 50/51

Cod.



J057111 **PRIMER** 1

Per aste mezze tonde 16x8 P.249

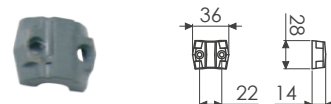

Incontro cremonese RA

Cod.



J057201 **GREZZO** 1

J057202 **PRIMER** 1

Per aste mezze tonde 16x5 P.249

Bloccaggio

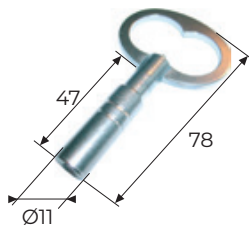

Chiave a quadro per RY 50/51

Cod.



J041192 **Z.BIANCO** 1

Chiavi da 6.